



SUBARU



IMPREZA



## WELCOME TO THE PLACE WHERE LIFE HAPPENS.

With reliability and safety you can count on and performance to get excited about, the Impreza is the foundation for your active life. The Impreza inspires people to get out and live more productive, enjoyable lives and to make every day and every opportunity more meaningful.





## AGILE, VERSATILE AND STYLISH. JUST LIKE YOU.

As enjoyable to drive as it is to behold, the Impreza artfully blends capability, craftsmanship, and safety for an experience to please all senses. Every bend, every surface, and every styling cue has a distinct and specific reason for being rooted in both form and function. It's an advanced and evolved expression of Subaru design—and a rolling symbol of everything the Impreza has always stood for.



ALL ROADS LEAD TO  
ENJOYMENT.



**SI-DRIVE\***

Based on your driving style, Subaru Intelligent Drive (SI-DRIVE) can adjust engine response to give you immediate power and agility when you crave it in nearly any scenario.

\* Optional.

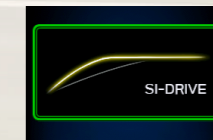

**Sport Mode**

This highly responsive mode is well suited for all-round conditions with its immediate acceleration. It puts the enjoyment back into high-speed driving on motorways or on winding roads.

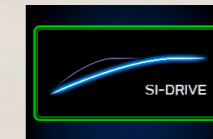

**Intelligent Mode**

Offering gentle power delivery, this mode is ideal for cruising around town on local streets, covering long distances, or achieving high fuel efficiency. It also provides flexible control in the rain or on snowy roads.



## VERSATILE DESIGN FOR EVERYTHING YOU LOVE TO DO.

To ambitious people, cargo matters. For work or play, the Impreza offers ample space to accommodate everything you'll need for the things you love doing. With enough luggage space to fit at least 3 golf bags\*, the Impreza pushes you to get the most out of life and every opportunity you get, so you'll spend less time planning and more time doing.

\* 9.5-inch golf bags used, with rear seats up.

### 01. LUGGAGE SPACE (SEDAN)

The sedan includes a spacious and practical luggage compartment to maximise your active lifestyle. Fold down the rear seats for a range of different layout options.

### 02. LUGGAGE SPACE (5-DOOR)

The luggage space of the 5-door model is especially easy to use. With a larger opening and wider compartment, the 5-door model's segment-leading versatility will match any active lifestyle.





## STYLE, COMFORT, AND ENJOYMENT FOR ALL.

Entering a new level of refinement, the Impreza boldly leaps forward with a quiet cabin that's rich in smooth, sculptured surfaces and careful attention to detail. The Impreza maintains an elegant and sporty design sense while giving the cabin a more spacious feel. All passengers can expect to enjoy the spacious front and rear seating of the Impreza—even on long rides.

### 01. REAR SEAT CENTRE ARMREST

The interior of the Impreza offers comfort for all passengers, with cup holders in the rear seat centre armrest.

### 02. FRONT SEATS

The Impreza features redesigned, stylish front seats that offer more support, comfort, and peace of mind.

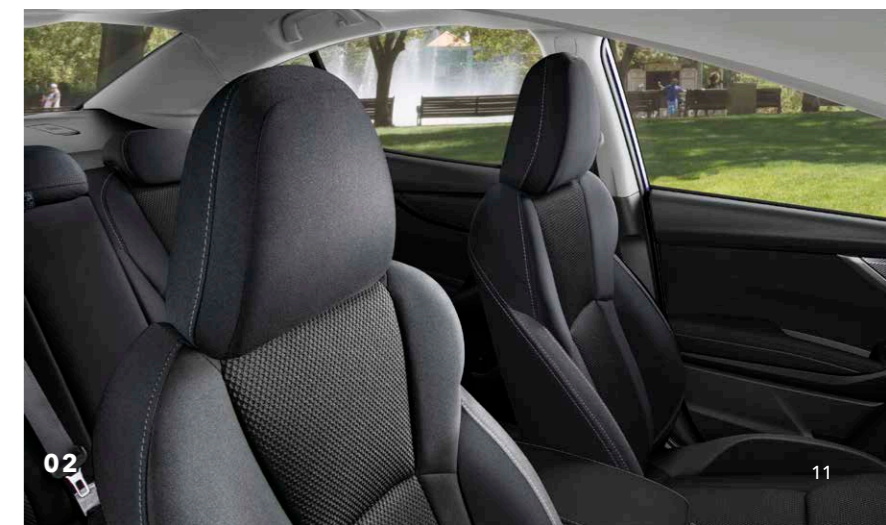

## STAY IN TOUCH. FEEL CONNECTED.

It's a fast-paced world we live in. That's why the Impreza is equipped with a completely redesigned next-generation infotainment system that keeps you connected wherever you go. An available 8-inch\*1 touchscreen head unit display provides intuitive access to listening content, while a redesigned multifunction display informs drivers on key vehicle stats. Connectivity between the head unit display, meter display, and multifunction display helps improve convenience, safety, and enjoyment. In touch and in control—that's how you'll always feel inside the Impreza.



### APPLE CARPLAY\*2 AND ANDROID AUTO\*3

Use today's most popular apps with Apple CarPlay\*2 and Android Auto\*3. Voice recognition capabilities allow hands-free use, keeping everybody safe while reducing distractions when you're on the road.



### MULTIFUNCTION DISPLAY

The 6.3-inch full-colour LCD multifunction display at the top of the instrument panel provides you and your passengers with useful information in an easy-to-understand view.



### METER DISPLAY

Now easier to see with its larger screen, the 4.2-inch full-colour LCD meter display helps you understand useful driving information with a quick glance so you can keep your eyes on the road.



### FRONT VIEW MONITOR

The front grille camera projects the vehicle's front view via the Multifunction Display, increasing front visibility at intersections and when parking facing a wall.

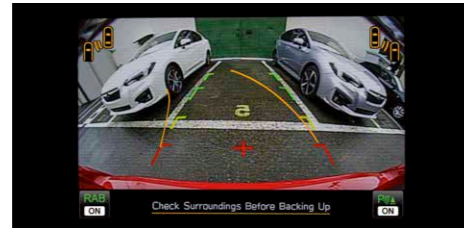

### REAR VIEW CAMERA\*4

Conveniently manoeuvre the Impreza in tight city spaces with ease. When you shift into reverse gear, the camera displays a live colour image on the head unit display along with guidelines to assist you with parking.

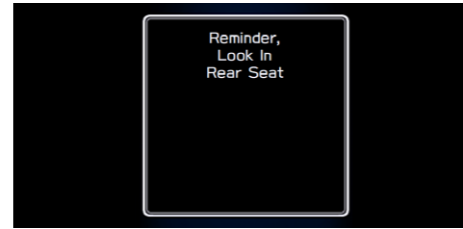

### REAR SEAT REMINDER

This system helps remind you via Meter Display and audible sound to check the rear seat area before leaving the vehicle.



\*1 Not available in all markets. Please check with your Subaru retailer for more details.  
 \*2 Apple CarPlay is a trademark of Apple Inc., registered in the U.S. and other countries.  
 \*3 Android and Android Auto are trademarks of Google Inc.  
 \*4 Optional.

Apple CarPlay and/or Android Auto may not be available for all models and regions. Please contact your local authorised Subaru retailer for more details. Driver is always responsible for safe and attentive driving. Please refrain from operating the touchscreen while driving. Package communications fee may be charged depending on your area.

# SUBARU CORE TECHNOLOGY

Subaru's core technologies identify the Subaru brand and give you the unique driving feel you can find only in a Subaru. These core systems allow Subaru vehicles to live up to its standards in performance, comfort, safety, and reliability while keeping its promise to deliver enjoyment and peace of mind to all passengers.

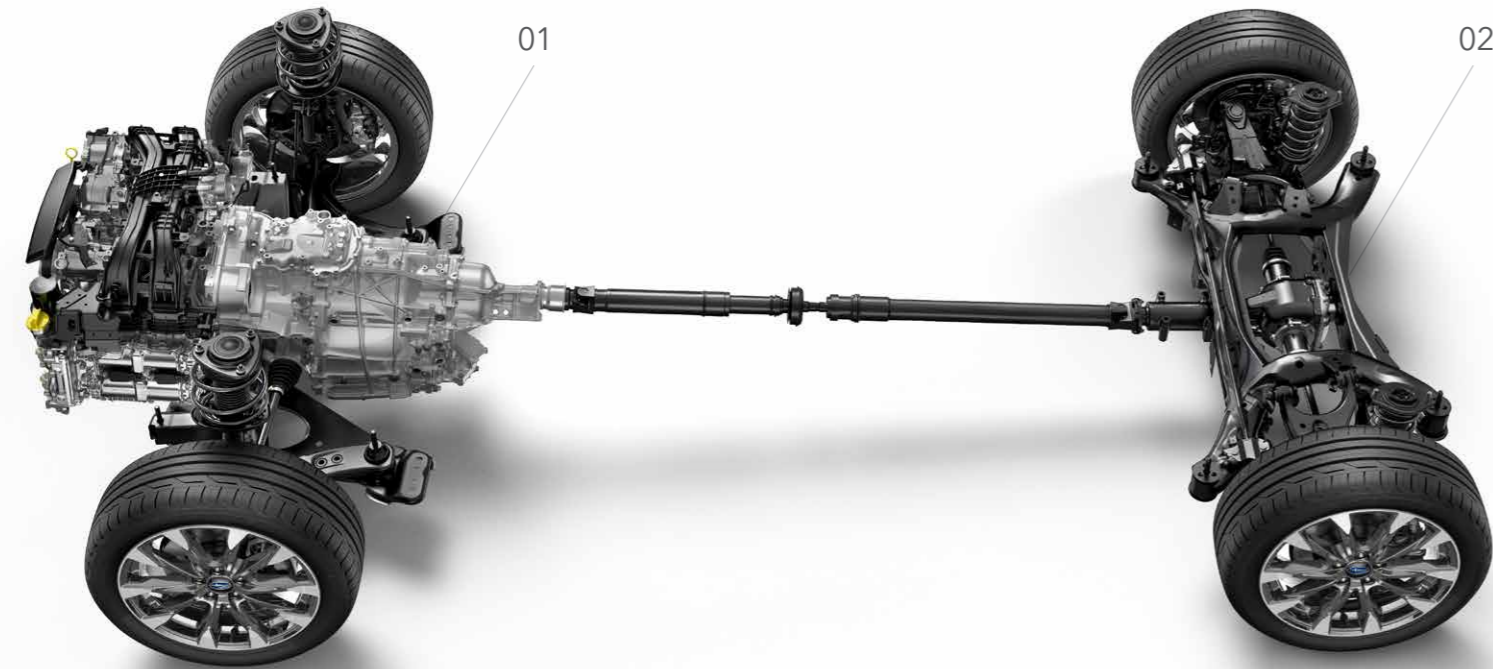

## 01 | LINEARTRONIC + ACTIVE TORQUE SPLIT AWD

Lineartronic adjusts to any ratio in its range for smooth and stepless gear changes that keep the engine in its most efficient range for efficient and smooth acceleration, driving performance and better fuel efficiency. It comes paired with Subaru's active torque split AWD system. Its default torque is well-balanced front to rear and adjusts in response to real-time traction conditions.

## 02 | SYMMETRICAL ALL-WHEEL DRIVE (AWD)

Subaru's Symmetrical AWD distributes power to all wheels for better traction on wet and slippery roads. Laid out in a horizontally symmetrical plane, this system has a well-balanced low centre of gravity design for a more stable and safer ride.

# SUBARU BOXER ENGINE

A boxer engine, or a horizontally opposed engine, is an engine configuration in which its pistons move toward each other in a horizontal direction. Subaru has been committed to the SUBARU BOXER engine for over 50 years for its many advantages over other engine types, providing durability and reliable performance in its vehicles.

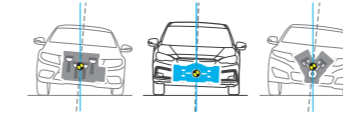

### Naturally Balanced

The engine's flat design is inherently rigid and self-balancing, generating less vibration than other engine types.

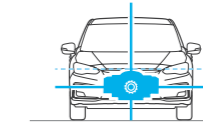

### Increased Stability

The low centre of gravity and flat design give it better side-to-side stability than other engine types.

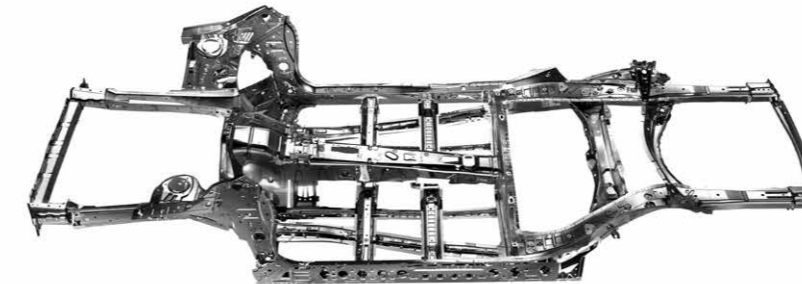

# SUBARU GLOBAL PLATFORM

The Subaru Global Platform (SGP) is the underlying platform that will underpin the next generation of Subaru vehicles. Enhancing all-around safety and performance, it goes beyond better performance to offer a driving feel you can only find in a Subaru. It's the future of Subaru—and delivers even more enjoyment and peace of mind to all drivers and passengers.

- 1. **More Fun to Drive** ----- More responsive handling allows the driver to steer the car as intended, also increasing hazard avoidance. The result is a car that's safer and more fun to drive, even on long trips.
- 2. **Ride Comfort** ----- Improvements in chassis rigidity, suspension, and stabilisers efficiently absorb shocks from the road and hide uneven surfaces, allowing more comfort and less fatigue on long rides.
- 3. **Comfortable Cabin Space** ----- Unpleasant vibrations and noise have been reduced to ensure all passengers enjoy the ride. Suspension improvements and a highly rigid chassis allow for a comfortable cabin interior for all.



# SUBARU ALL-AROUND SAFETY

When your car gives you peace of mind, life becomes more enjoyable. That's why at Subaru, safety comes first. Originally rooted in aircraft manufacturing, Subaru continues its 'people first' policy by fine-tuning, testing, and retesting its advanced safety features, developed over 50 years. With the latest in collision protection/avoidance systems and unique technologies like Subaru Global Platform and Symmetrical All-Wheel Drive, Subaru continuously strives to improve All-Around Safety to envision an accident-free future.

## PRIMARY

Primary Safety begins at the underlying design stage. Outstanding visibility, optimal driving position, and intuitive controls help keep you safe from the moment you enter your vehicle.

## PREVENTIVE

With advanced safety technologies such as EyeSight\*, Preventive Safety helps avoid collisions before they happen.

## ACTIVE

Thanks to technologies like Symmetrical All-Wheel Drive and SGP, Active Safety allows precise control of your vehicle by fine-tuning the basic elements of driving—driving, turning, braking—so you can enjoy each drive with peace of mind.

## PASSIVE

Passive Safety is designed to keep you safe in the event of a collision, with features such as the cabin-protecting engine layout and SRS\*<sup>2</sup> airbags.

01



01 PASSIVE

### Ring-shaped Reinforcement Frame

The Ring-shaped Reinforcement Frame makes better use of high-tensile steel panels and has been structurally redesigned for more efficient energy absorption from impacts in all directions.

06 PREVENTIVE

### Steering Responsive Headlights (SRH)

These headlights operate interconnectedly with steering input and vehicle speed to aim your lights in the direction your vehicle is turning, helping you see better around corners for safer nighttime driving.

02

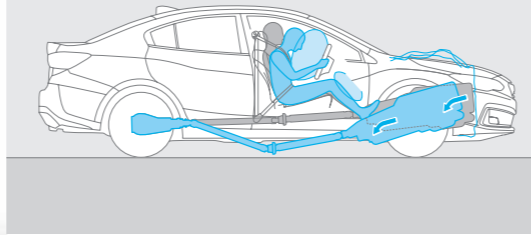

02 PASSIVE

### Cabin-protecting Layout

Now sitting lower than ever due to the low centre of gravity design of the SGP, the engine and gearbox are designed to avoid crashing into the cabin in the event of a collision.

07 PREVENTIVE

### Reverse Automatic Braking (RAB)\*<sup>3</sup>\*<sup>4</sup>

When in Reverse, this system uses four sensors on the rear bumper to detect obstructions behind the vehicle. If detected, the system can alert the driver with warning sounds and automatically apply the brakes to avoid a collision or reduce collision damage.

04

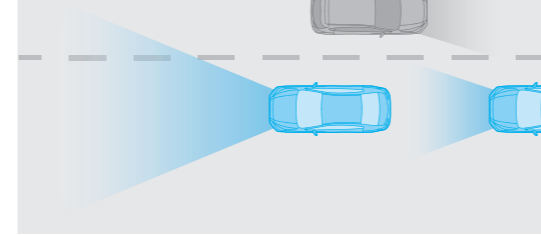

03 PRIMARY

### Visibility in all directions

Optimal driving position, window heights, and carefully arranged pillars provide excellent visibility in all directions to reduce blind spots, letting you easily check your surroundings.

08 ACTIVE

### Vehicle Dynamics Control System

If the vehicle approaches the limits of stability, the AWD torque distribution, engine output, and brakes at each wheel are adjusted to assist in keeping the vehicle on course.

\*1 EyeSight is a driving support system which may not operate optimally under all driving conditions. The driver is always responsible for safe and attentive driving and observance of traffic regulations. System effectiveness depends on many factors such as vehicle maintenance, weather, and road conditions. See Owner's Manual for complete details on system operation and limitations for EyeSight, including functions in this brochure.

\*2 SRS: Supplemental Restraint System. Effective when used in conjunction with seatbelts.

06



04 PREVENTIVE

### High Beam Assist (HBA)\*<sup>3</sup>

High Beam Assist increases visibility and safety when driving at night by toggling the high beams on and off automatically, depending on driving conditions.

09 ACTIVE

### Auto Vehicle Hold

When the vehicle is at a complete stop, Auto Vehicle Hold keeps the vehicle in place even when the brake pedal is released, reducing driver fatigue in stop-and-go traffic.

\*3 The driver is always responsible for safe and attentive driving and observance of traffic regulations. Please do not depend solely on the Advanced Safety Package features for safe driving. There are limitations to the features of this system. See Owner's Manual for complete details on system operation and limitations. Please ask your retailer for more details.

\*4 Optional.

08

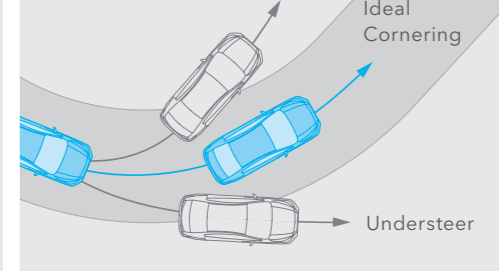

09

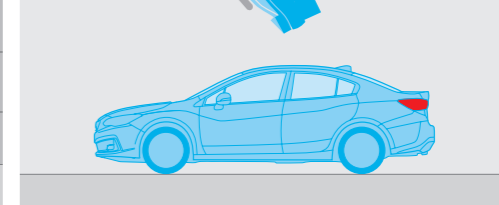

10

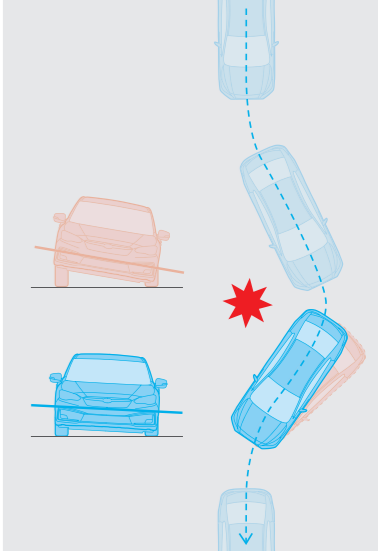

05 PREVENTIVE

### Subaru Rear Vehicle Detection (SRVD)\*<sup>3</sup>

Sensors placed around the vehicle alert you of vehicles in your rear blind spots for safer lane changes. It also warns you of potential collision danger while driving in reverse into a street with cross traffic.

10 ACTIVE

### Hazard Avoidance

Made possible by the SGP, the lower centre of gravity design, enhanced suspension system, and rigidity improvements provide a vehicle that responds immediately when evasive actions are taken, helping avoid hazards on the road.

## SUBARU'S WORLD-LEADING DRIVER ASSIST TECHNOLOGY

At Subaru, we believe in ALL-AROUND SAFETY, and an important part of that is pre-collision safety, making sincere efforts to ensure an accident never happens. That's why we created EyeSight<sup>\*1</sup>, Subaru's cutting-edge driving support system. Like a second pair of eyes for the road ahead, EyeSight uses two stereo cameras to capture three-dimensional colour images with excellent image recognition, nearly as capable as the human eye. Using images from both cameras to precisely determine the shape, speed and distance, it not only detects vehicles but also motorbikes, bicycles, and pedestrians.\*<sup>2</sup> When spotting potential danger, it warns the driver and even applies the brakes if necessary to help avoid an accident. With improved safety performance like this, EyeSight reduces the burden on the driver and enhances your sense of security in the Impreza.

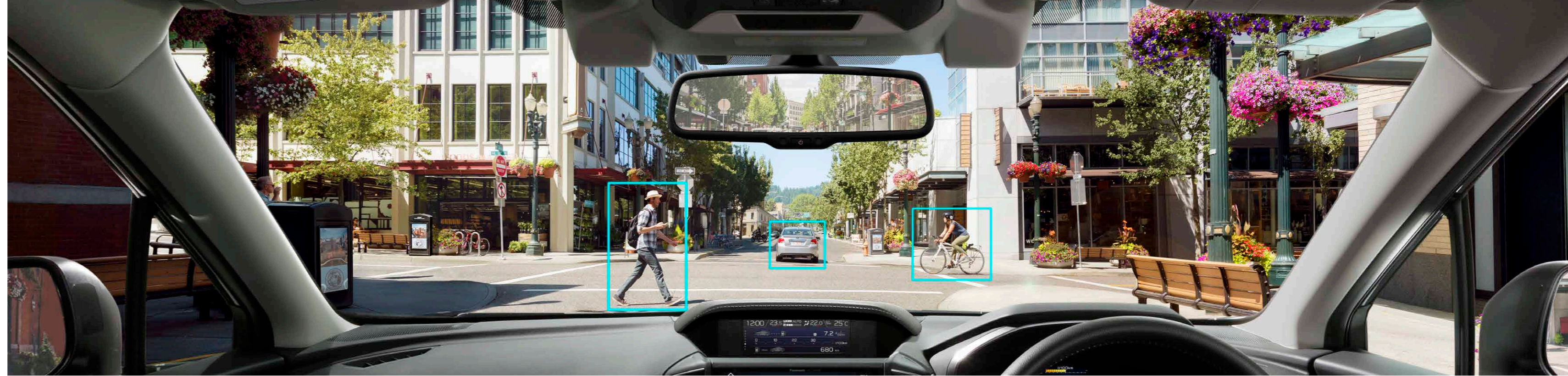

### DRIVER ASSIST

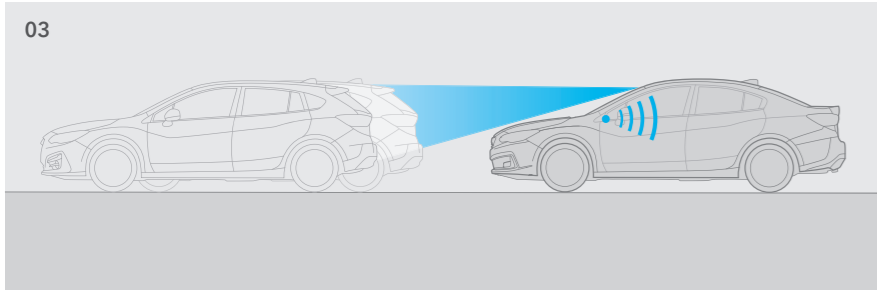
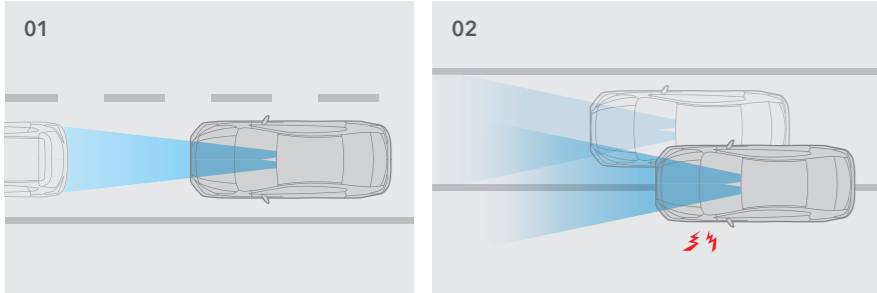

#### 01. ADAPTIVE CRUISE CONTROL

EyeSight<sup>\*1</sup> doesn't only maintain the speed the driver sets as traditional cruise control does. When it senses a vehicle in front, Adaptive Cruise Control adjusts the speed to keep a set distance from the lead vehicle by monitoring the distance and the difference of the speed. It adjusts the engine, transmission, and brake to keep your speed in line with the traffic flow in a wide range approximately from 0 km/h to 180 km/h. Designed for use on freeways, highways, and similar roads, Adaptive Cruise Control actually detects a lead vehicle and its brake lamps and can help keep pace in stop-and-go highway traffic for you—a comfort and convenience on long drives.

#### 03. LEAD VEHICLE START ALERT

When you're at a stop and EyeSight senses that traffic has started moving again, Lead Vehicle Start Alert prompts the driver to take action with a buzzer and a flashing indicator.

#### 02. LANE SWAY AND DEPARTURE WARNING

When you are distracted by fatigue and are wandering or drifting in a lane, Lane Sway Warning helps you stay alert with a buzzer and a flashing indicator. However, Lane Sway Warning only activates at speeds of approximately 60 km/h or more. When travelling at speeds of approximately 50 km/h or more and you accidentally drift to the edge of your lane and begin to depart your lane without signaling, Lane Departure Warning warns you with a buzzer and a flashing indicator before you leave your lane.

### ACCIDENT PREVENTION

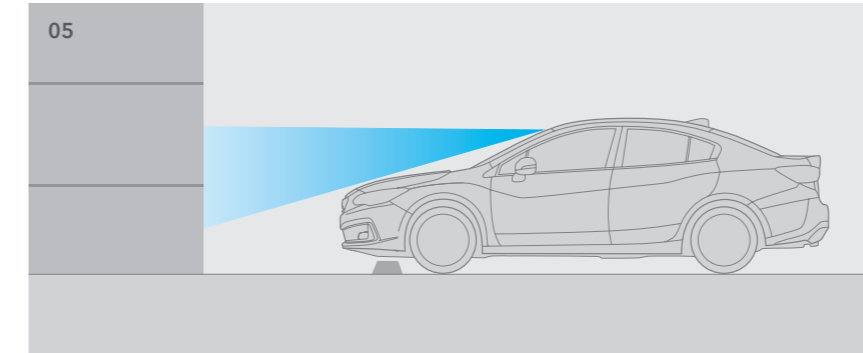
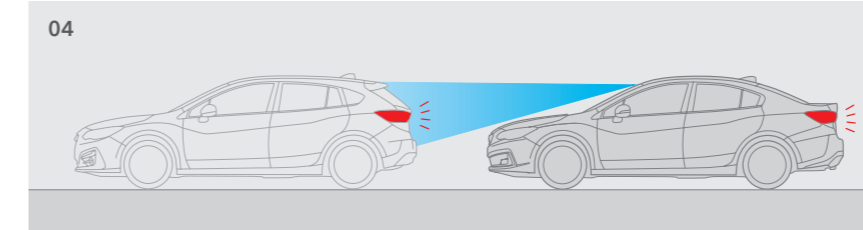

#### 04. PRE-COLLISION BRAKING SYSTEM<sup>\*2</sup>

When it senses an impending collision with a vehicle or other obstacle in front, the Pre-Collision Braking System can warn the driver with a buzzer and a light on your dash. If the driver still does not take evasive action to avoid the collision, the system can automatically apply the brakes to reduce any impact or, if possible, prevent the collision. If the driver takes evasive action to avoid a collision, Pre-Collision Brake Assist can act to aid the driver in preventing the collision.

#### 05. PRE-COLLISION THROTTLE MANAGEMENT

When EyeSight sees an obstacle in front of you and you put the vehicle in Drive instead of Reverse, Pre-Collision Throttle Management sounds several short beeps, turns on a flashing indicator and cuts the engine output to help you avoid a frontal collision.

<sup>\*1</sup> EyeSight is a driving support system which may not operate optimally under all driving conditions. The driver is always responsible for safe and attentive driving and observance of traffic regulations. System effectiveness depends on many factors such as vehicle maintenance, weather, and road conditions. See Owner's Manual for complete details on system operation and limitations for EyeSight including functions in this brochure.

<sup>\*2</sup> Pre-Collision Braking System may not work in all situations. Depending on the speed difference from objects, the object's height, and other conditions, every situation may not meet the necessary conditions for EyeSight to work optimally.

For illustration purposes only. Not actual measurements.

**LINEUP**

**IMPREZA 2.0i-S EyeSight / 2.0i-S**

DIMENSIONS (SEDAN) ..... L x W x H: 4640 x 1775 x 1455 mm  
 DIMENSIONS (5-DOOR) ..... L x W x H: 4475 x 1775 x 1480 mm  
 ENGINE ..... Horizontally opposed, 4-cylinder, DOHC 16-valve, petrol direct injection  
 CAPACITY ..... 1995 cc  
 MAX OUTPUT ..... 115 kW (156 PS) / 6,000 rpm  
 MAX TORQUE ..... 196 Nm (20.0 kgfm) / 4,000 rpm  
 TRANSMISSION ..... Lineartronic, AWD



Magnetite Grey Metallic



**IMPREZA 1.6i-S EyeSight / 1.6i-S**

DIMENSIONS (SEDAN) ..... L x W x H: 4640 x 1775 x 1455 mm  
 DIMENSIONS (5-DOOR) ..... L x W x H: 4475 x 1775 x 1480 mm  
 ENGINE ..... Horizontally opposed, 4-cylinder, DOHC 16-valve, petrol  
 CAPACITY ..... 1600 cc  
 MAX OUTPUT ..... 84 kW (114 PS) / 6,200 rpm  
 MAX TORQUE ..... 150 Nm (15.3 kgfm) / 3,600 rpm  
 TRANSMISSION ..... Lineartronic, AWD



Ice Silver Metallic



## FEATURES



01



02

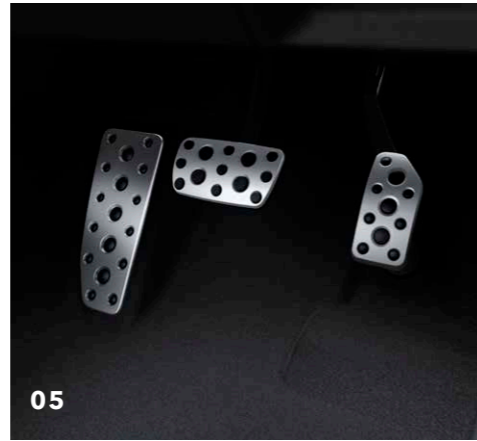

05



06



03



04



07



08

### 01. LED Headlamps with Auto-leveliser

These auto-leveling bifunctional LED headlamps combine low and high beams and are steering-responsive, ensuring good visibility around turns at night.

### 02. Power-folding Door Mirrors

These power-folding side mirrors can conveniently be electrically folded in for narrow parking spaces.

### 05. Aluminium Pedals

These motorsports-inspired pedals give the interior an exciting feel.

### 06. Dual-zone Automatic Air-conditioning System

The redesigned air-conditioning system distributes air efficiently and silently with improved vent directional flow for a more comfortable cabin in any weather.

### 03. 17-inch Aluminium-alloy Wheels

The stylish aluminium-alloy wheels are painted black on the inside to boost its solid and sporty appeal.

### 04. LED Rear Combination Lamps

The horizontal design of the LED rear combination lamps boost the wide and sporty exterior look.

### 07. 8-way Power Adjustable Driver's Seat

Find your ideal driving position with this 8-way power adjustable driver's seat so you can drive long distances in comfort.

### 08. USB and Auxiliary Audio Input Jack

Conveniently play your favourite songs through the audio system with just about any music player.

## EXTERIOR COLOURS

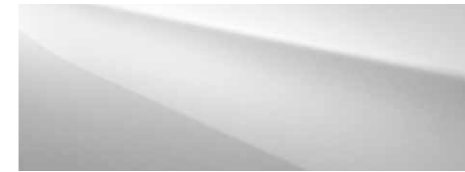

Crystal White Pearl



Ice Silver Metallic

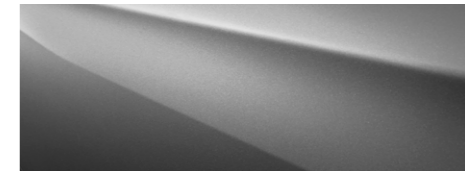

Magnetite Grey Metallic

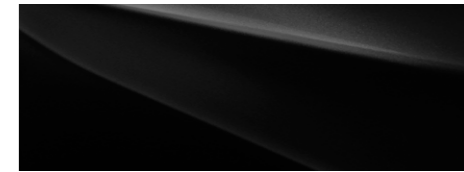

Crystal Black Silica

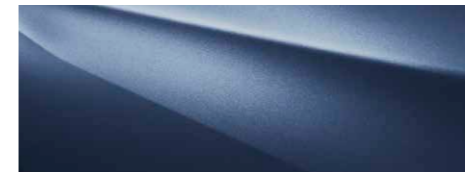

Quartz Blue Pearl

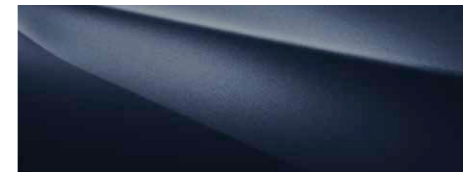

Dark Blue Pearl



Pure Red

## SEAT MATERIALS

### Black Leather\*



Seat Trim

Seat Backing

### Black Fabric\*

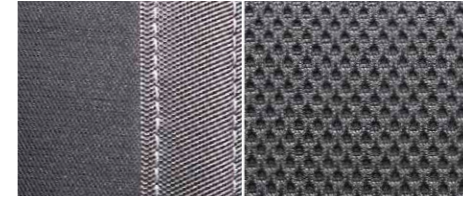

Seat Trim

Seat Backing

### Ivory Leather\*



Seat Trim

Seat Backing

### Ivory Fabric\*

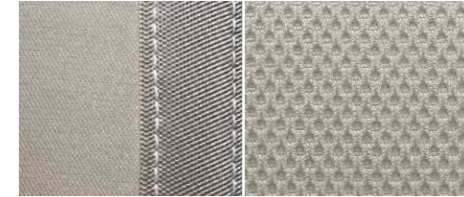

Seat Trim

Seat Backing

Owing to printing locations, colours may differ slightly from those shown in this chart. In addition, colours and seat variations may vary according to the individual market. \* Optional.

## DIMENSIONS

Dimensions are measured in accordance with standard measurement of SUBARU CORPORATION.

### Sedan

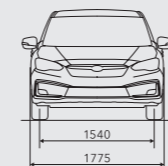

1540

1775

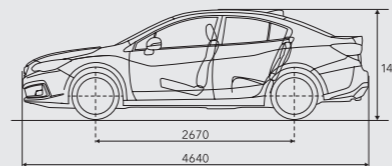

2670

4640

1455

### 5-door

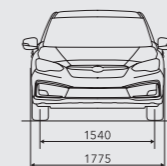

1540

1775

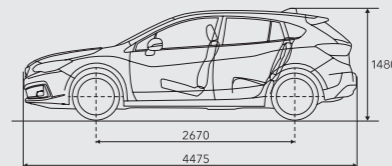

2670

4475

1480

Not all features, options, or packages are available for all models and regions. See your specification sheet for availability. Please contact your local authorised Subaru retailer for more details.

SUBARU CORPORATION reserves the right to alter specifications and equipment without notice. Details of specifications, equipment, colour availability and the lineup are subject to suit local conditions and requirements. Please inquire at your local retailer for details of any changes that might be required for your area.

subaru-global.com

SUBARU CORPORATION

Printed in Japan (20BR GKY 2019.12)

### **Subaru Interactive Experience**

To help you explore all things Subaru, we offer various digital materials with a wide range of exciting, interactive content such as 360-degree views and videos.

[subaru-global.com/ebrochure](http://subaru-global.com/ebrochure)

[youtube.com/user/SubaruGlobalTV](https://youtube.com/user/SubaruGlobalTV)